

20.76.1303.00

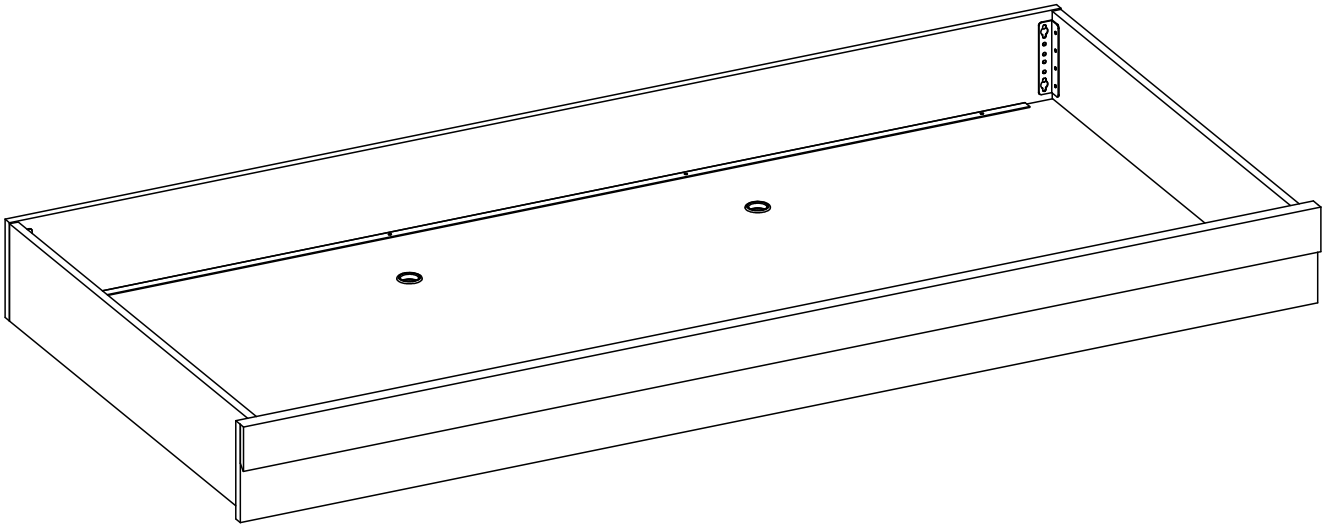

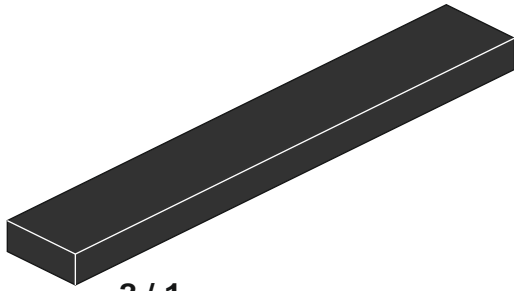

2 / 1

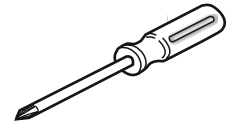
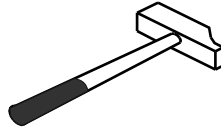
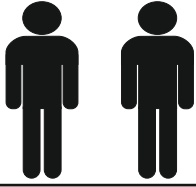
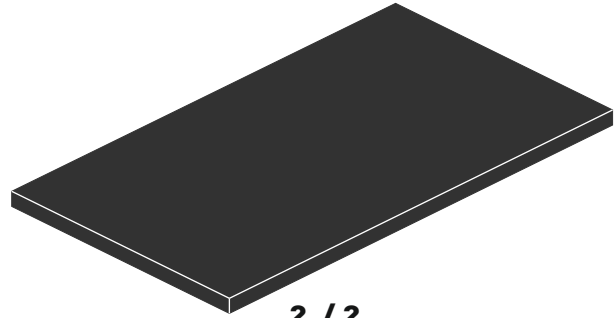

2 / 2



4x16

13.02.01.004 x 12



13.02.01.017 x 24



M6x13

13.03.01.021 x 16



4,2X16

13.02.01.015 x 16



13.01.01.005 x 4

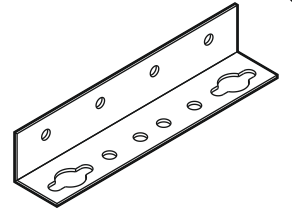

13.07.01.082 x 4

2 / 1

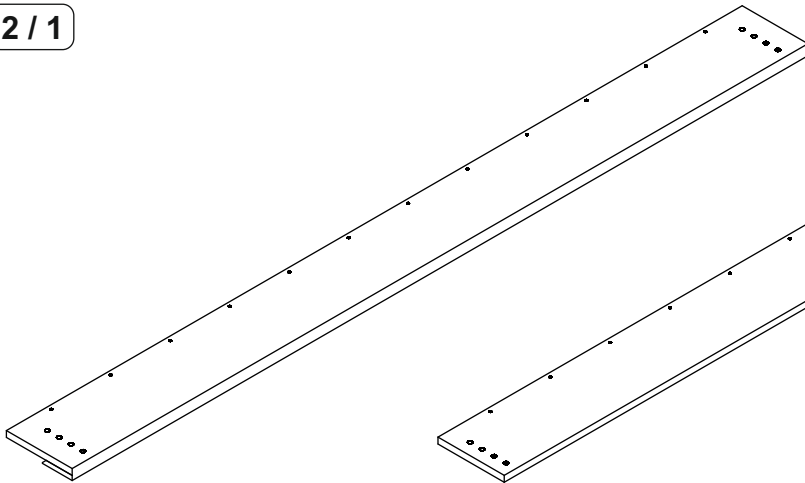

18.76.1303.001 x 1

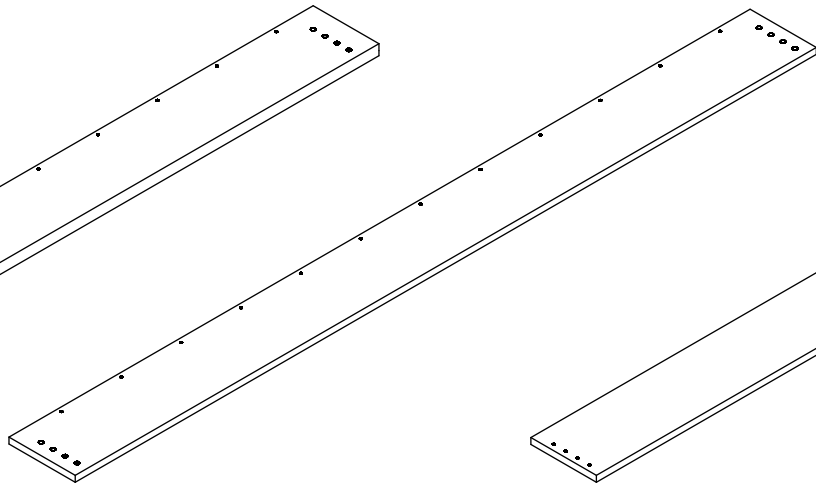

18.76.1303.002 x 1

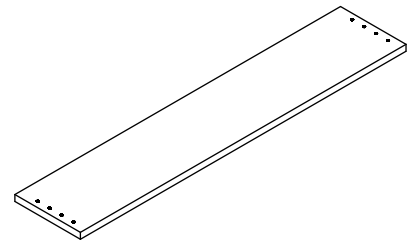

18.76.1303.003 x 2

2 / 2

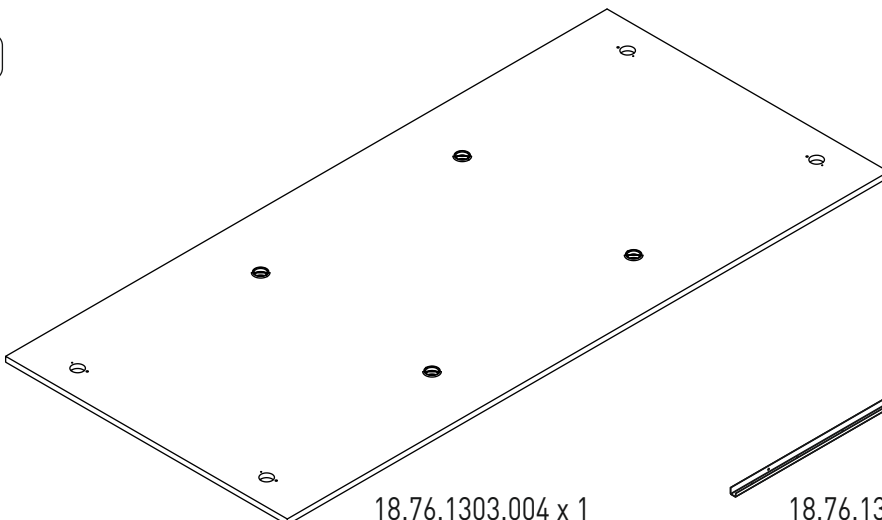

18.76.1303.004 x 1

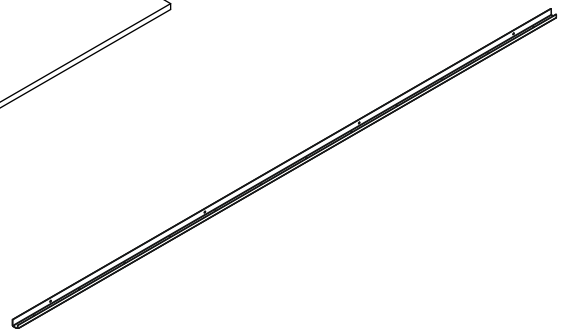

18.76.1303.201 x 2

1

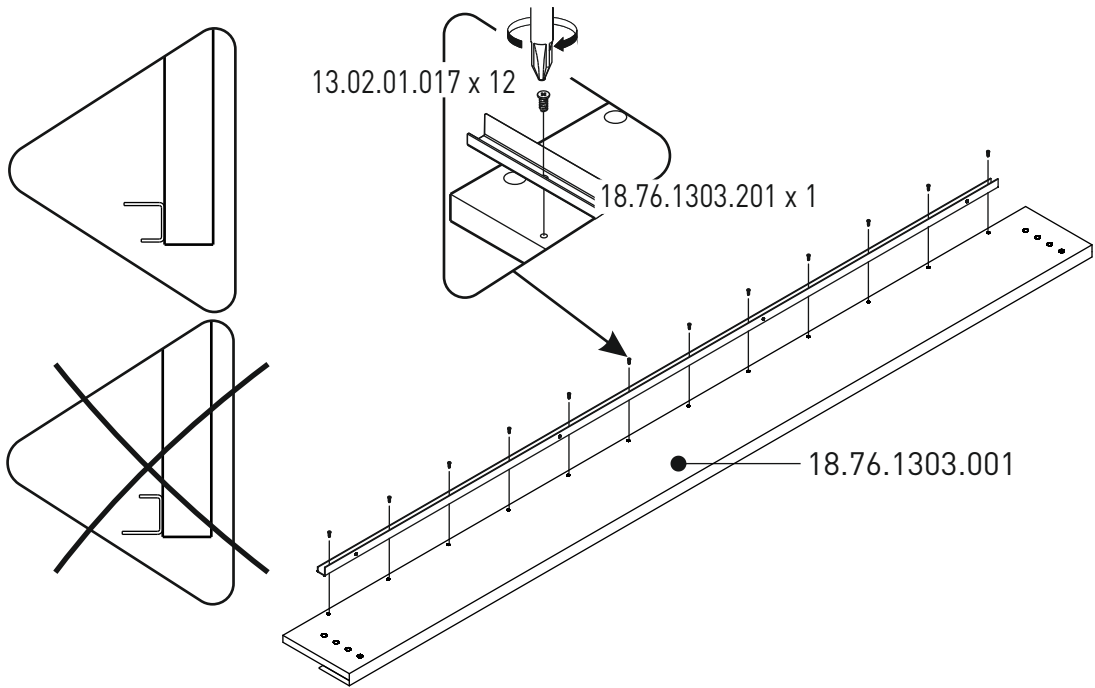

2

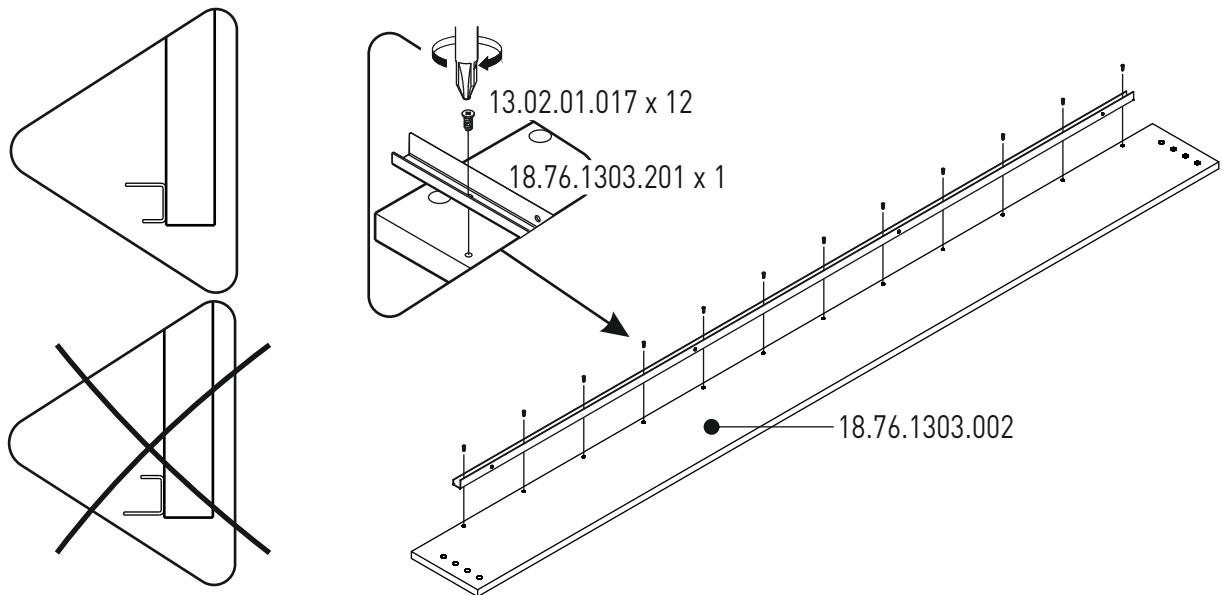

3

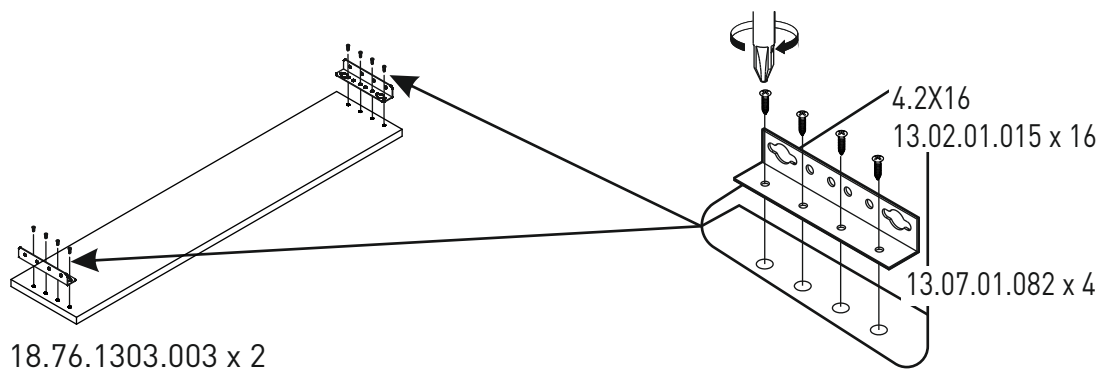

4

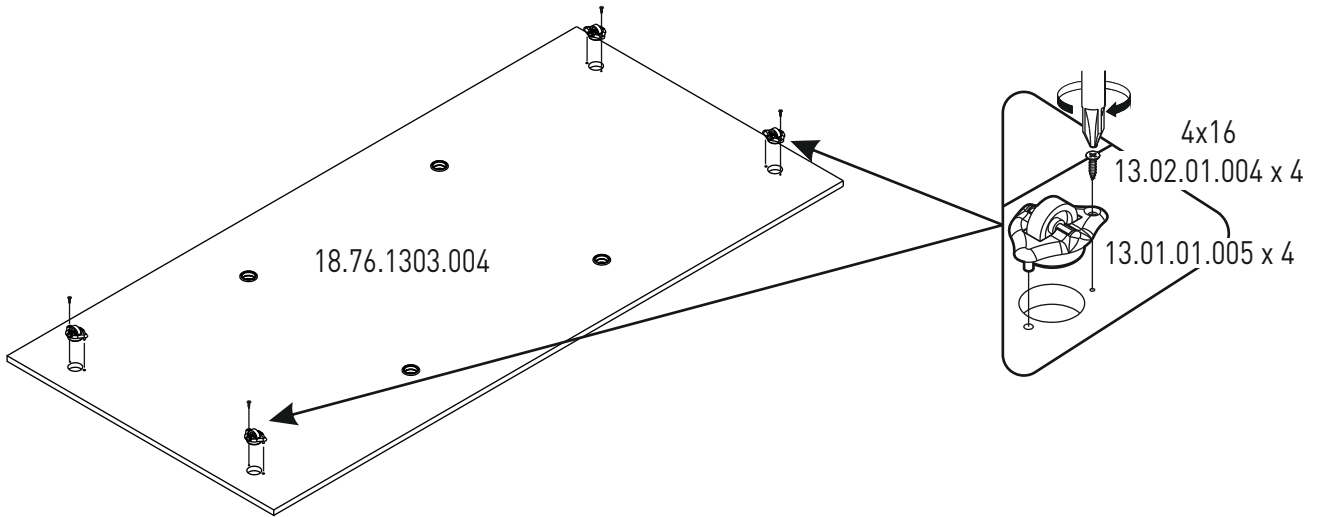

5

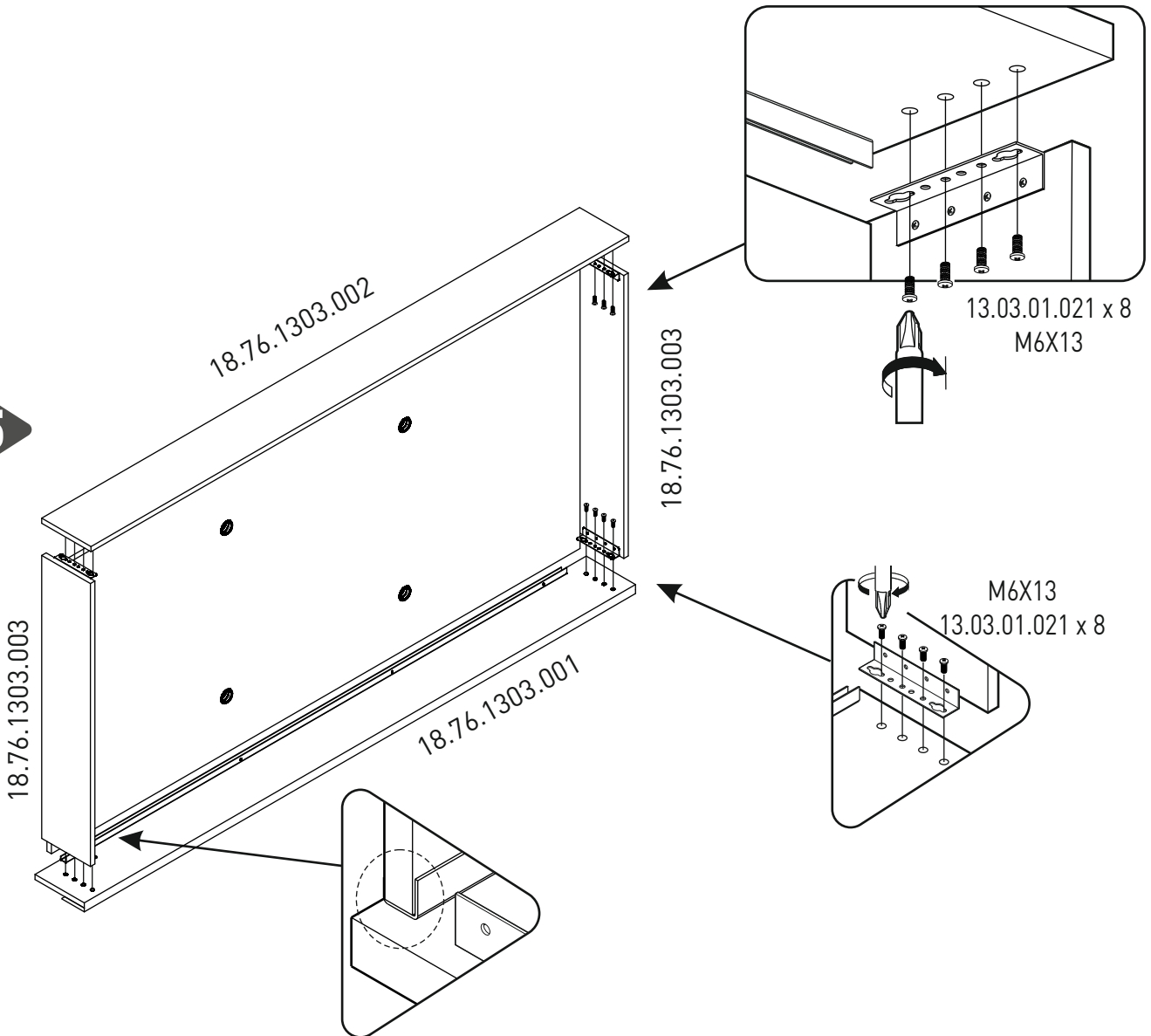

6

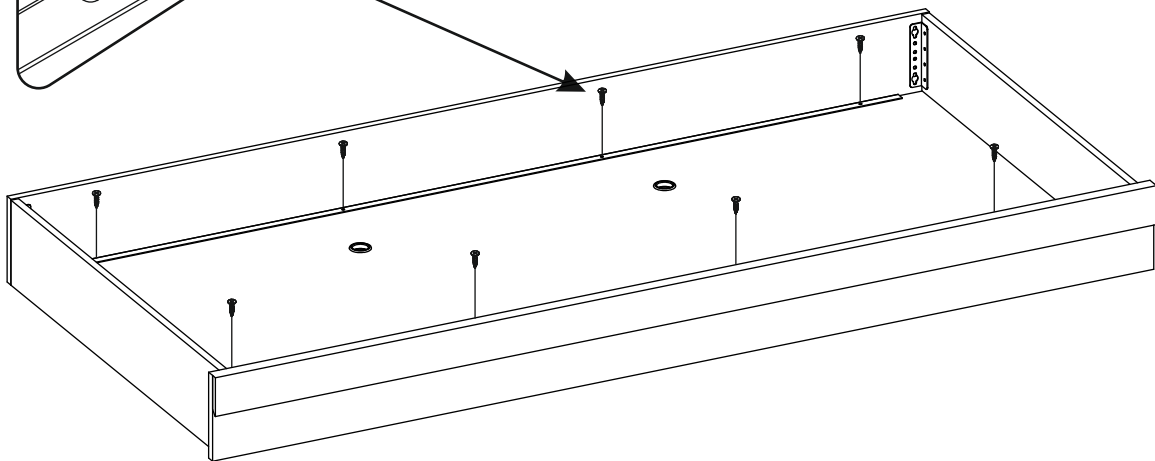
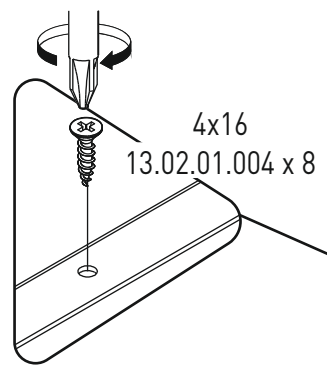

!

