

**20.50.1312.00**

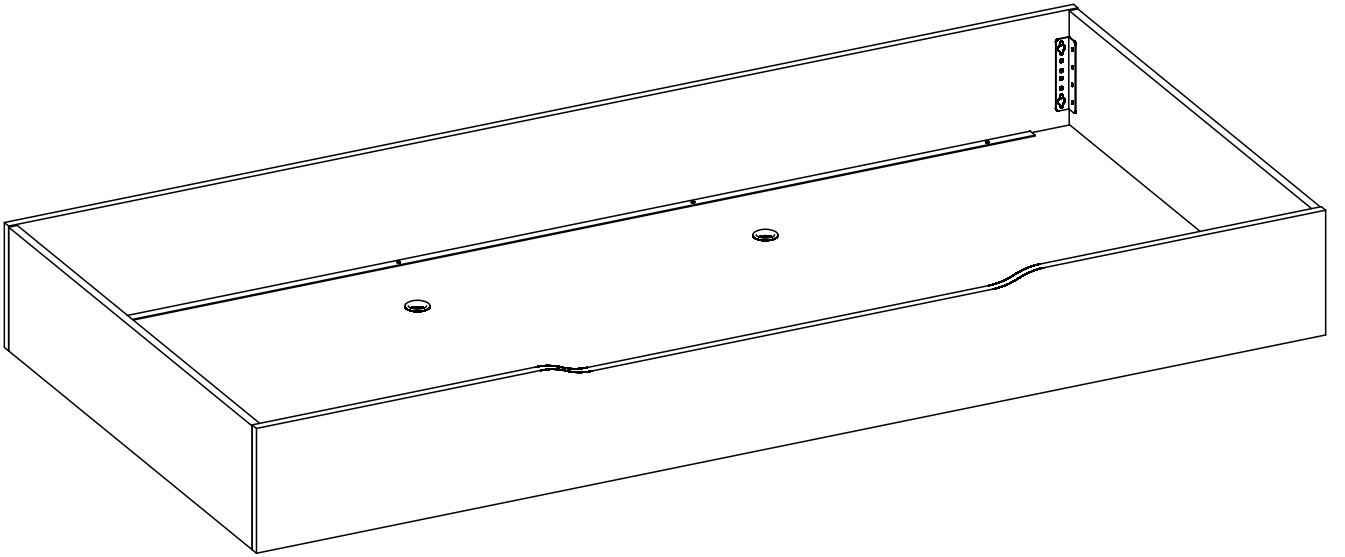

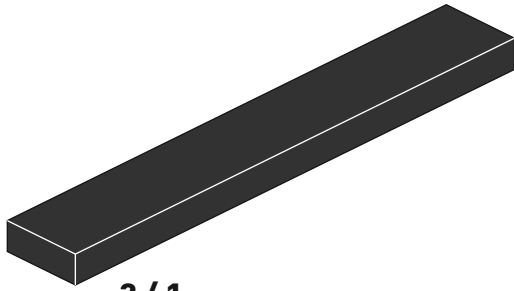

2 / 1

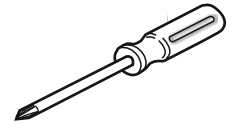
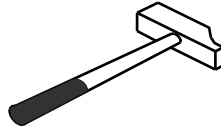
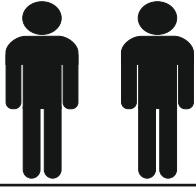
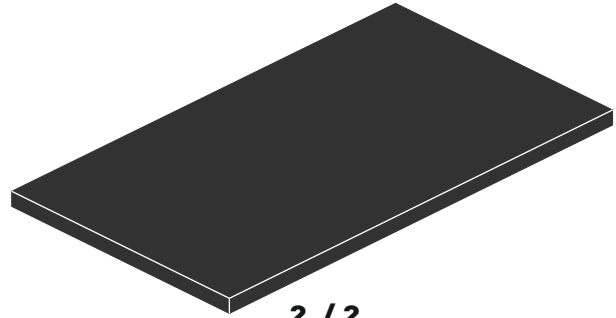

2 / 2



4X16  
13.02.01.004 x 12



13.02.01.017 x 24



M6X13  
13.03.01.021 x 16



4,2X16  
13.02.01.015 x 16

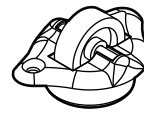

13.01.01.005 x 4

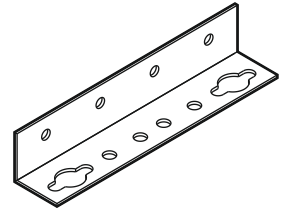

13.07.01.082 x 4

2 / 1

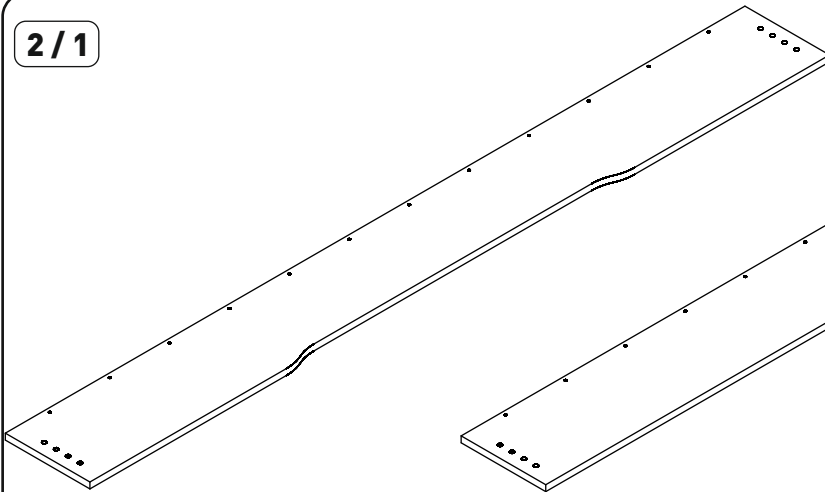

18.50.1312.001 x 1

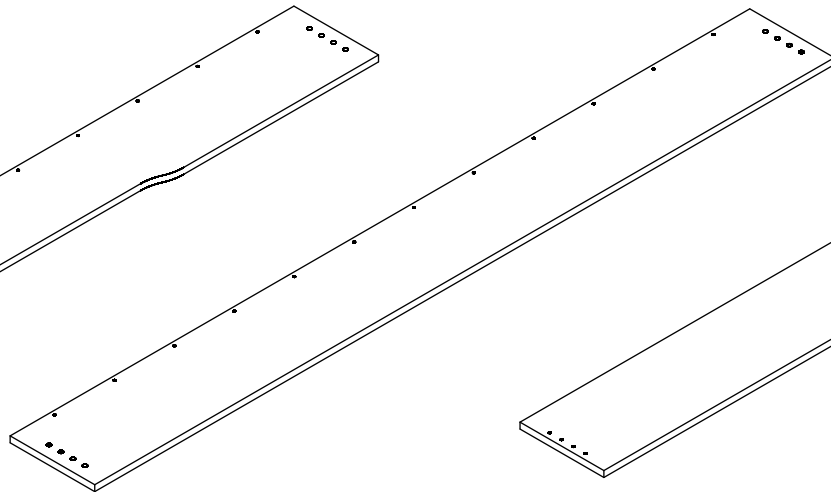

18.50.1312.002 x 1

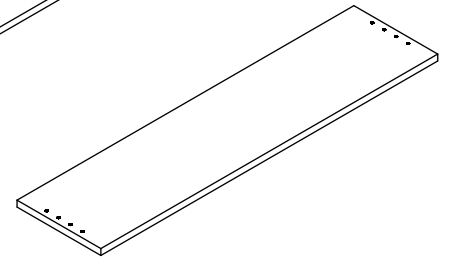

18.50.1312.003 x 2

2 / 2

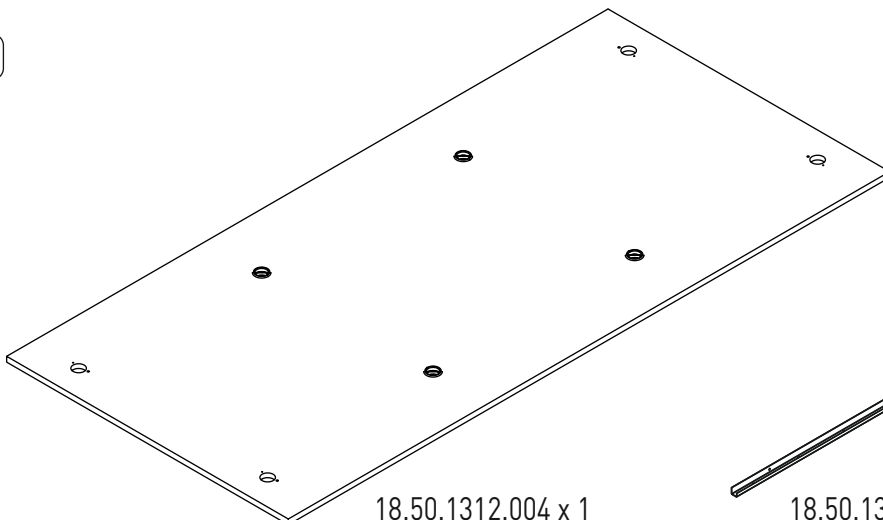

18.50.1312.004 x 1

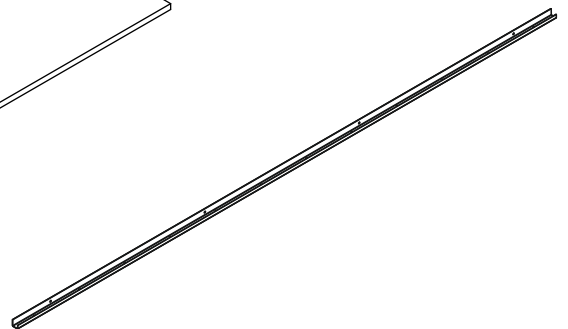

18.50.1312.201 x 2

1

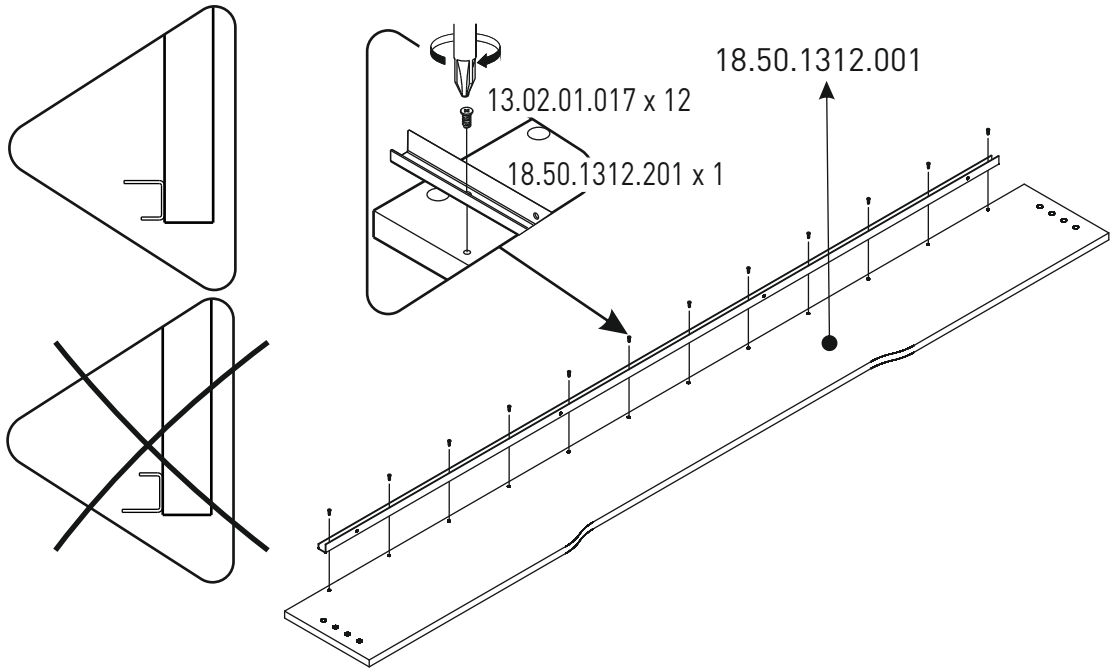

2

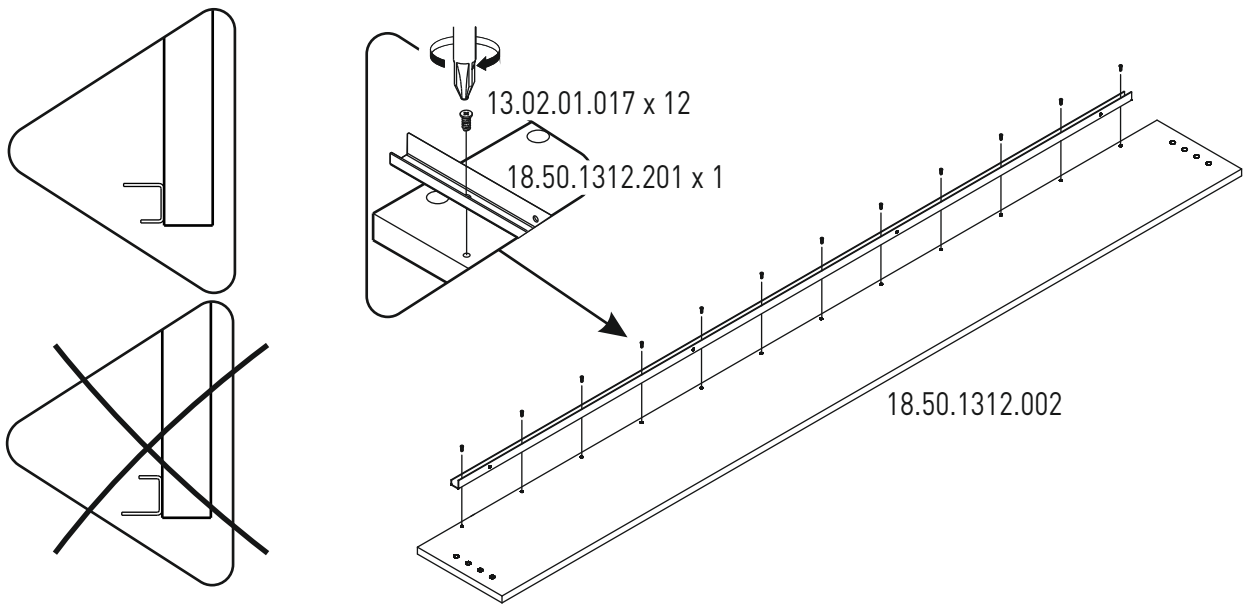

3

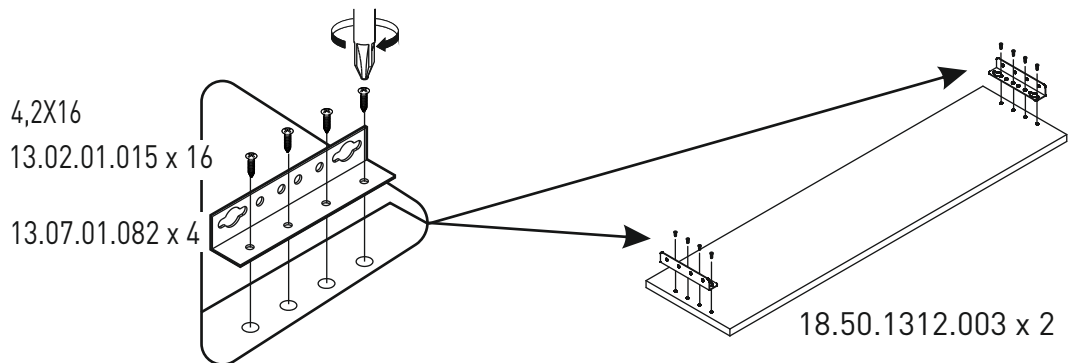

4

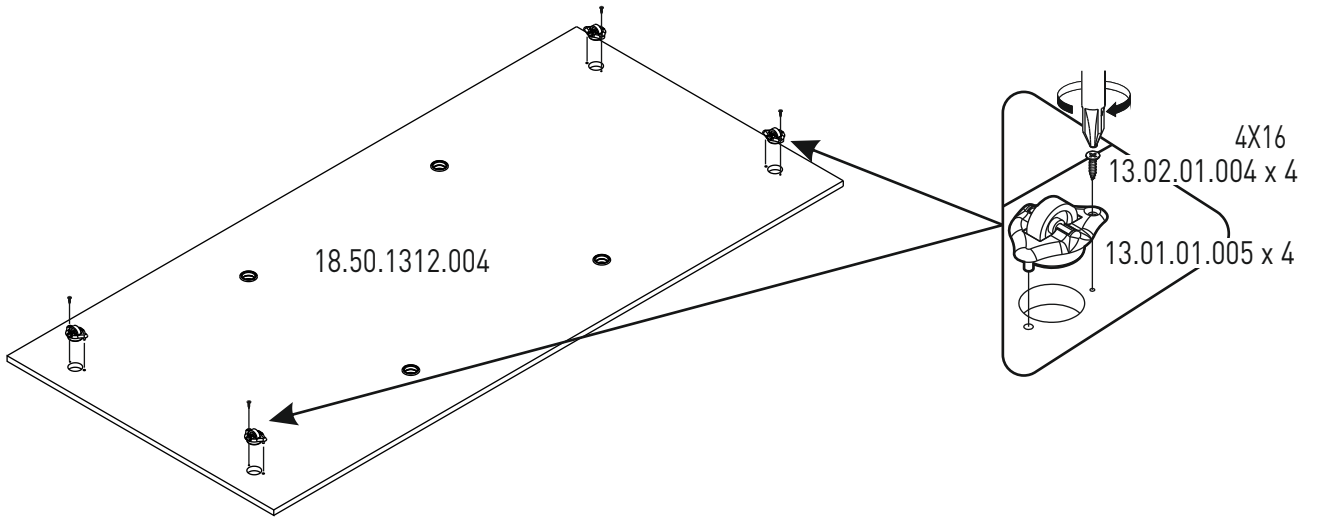

5

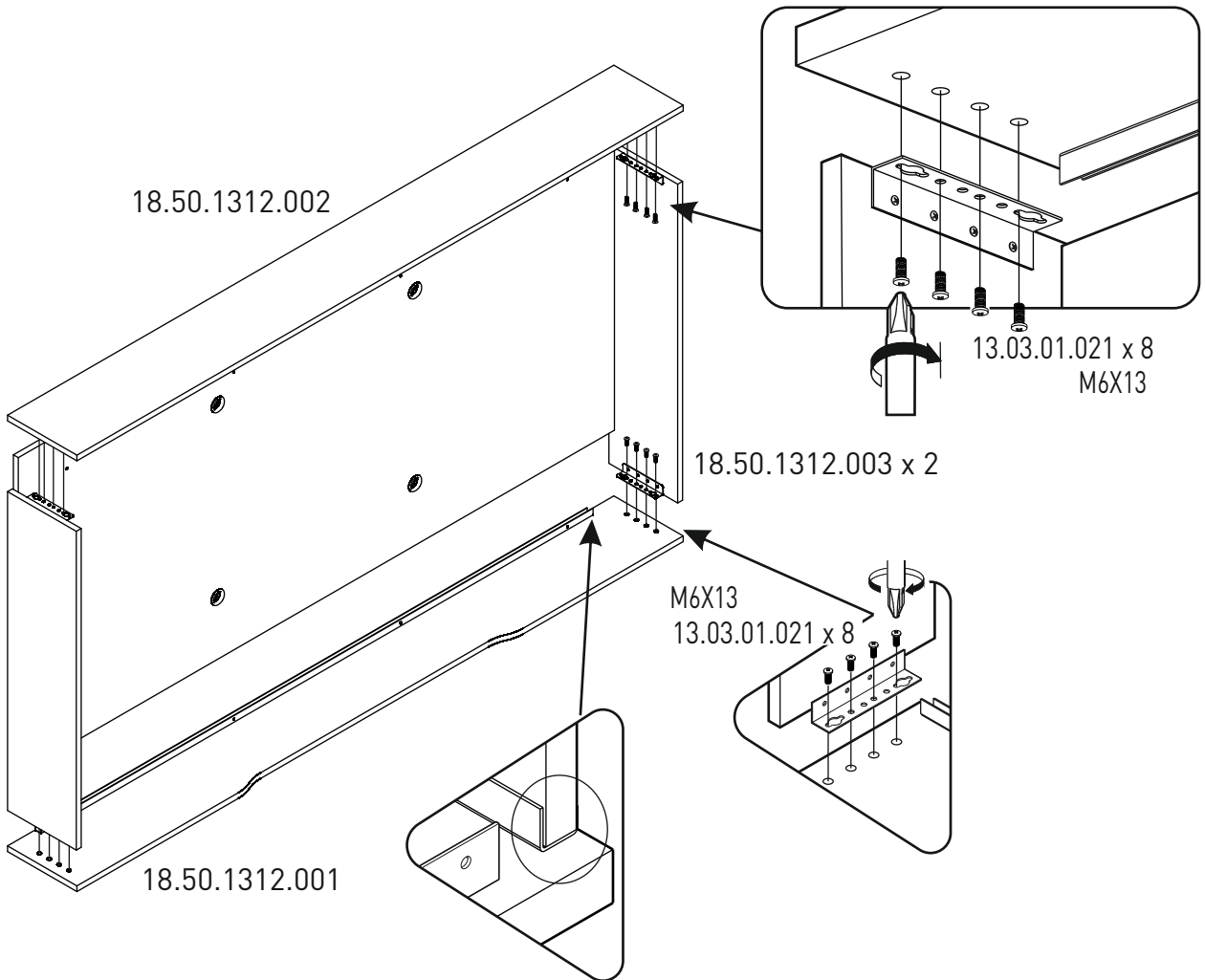

6

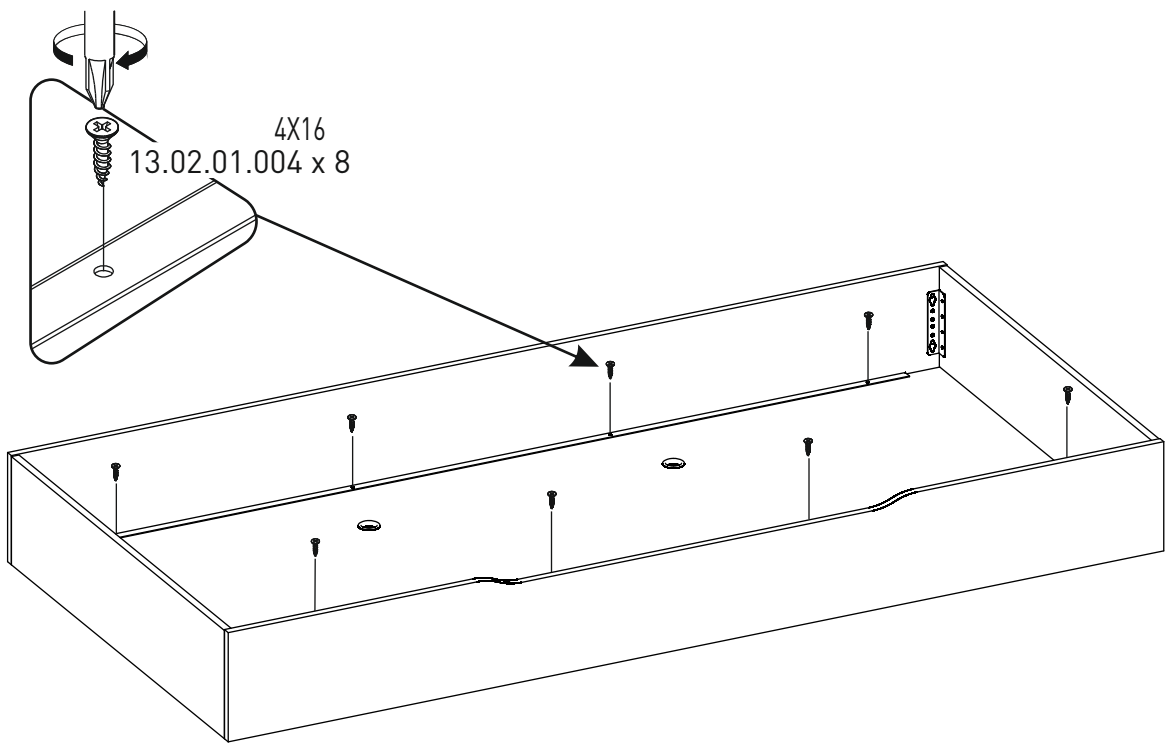

!

