

20.58.1302.00

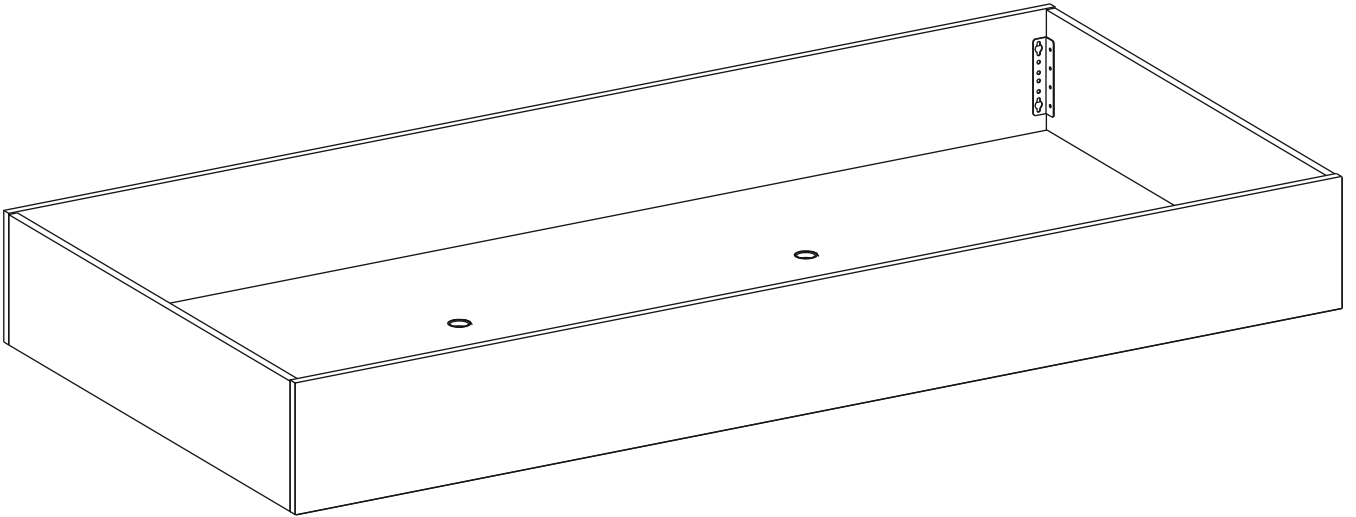

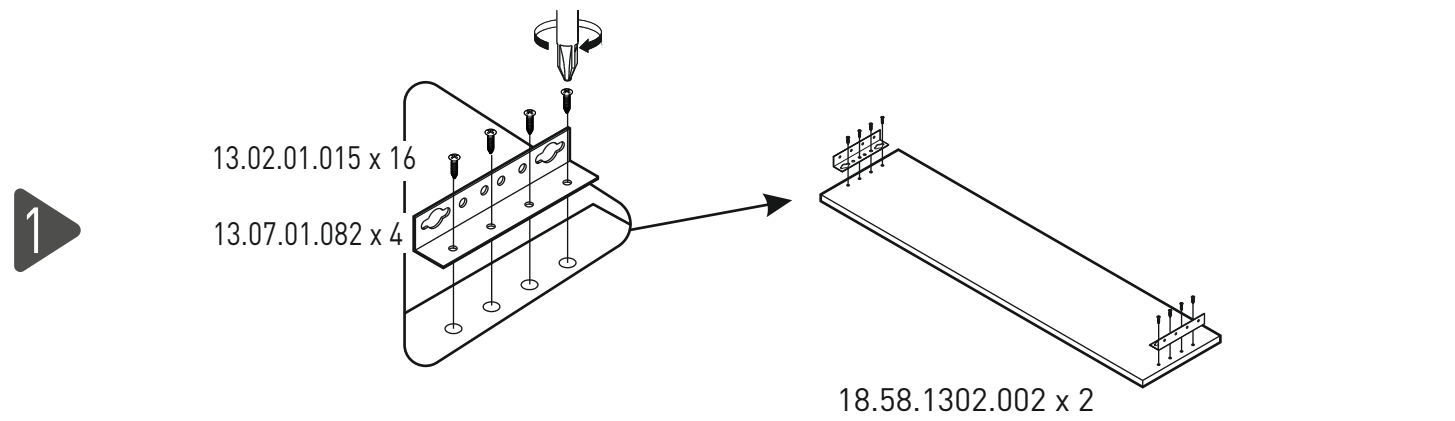

2

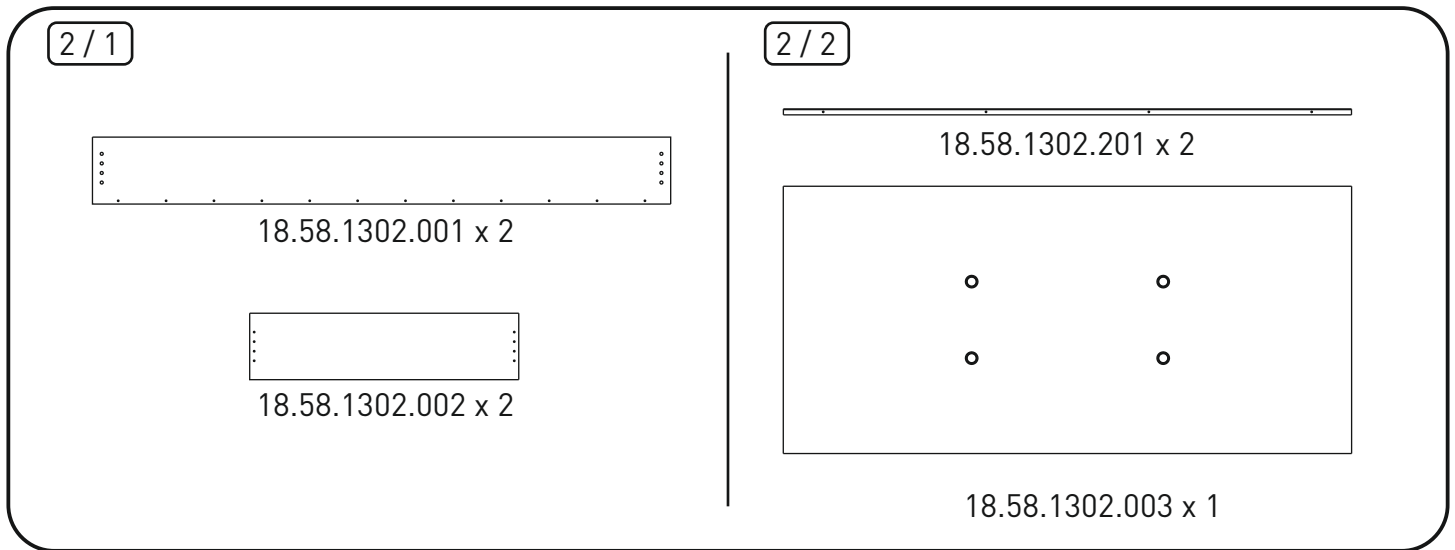
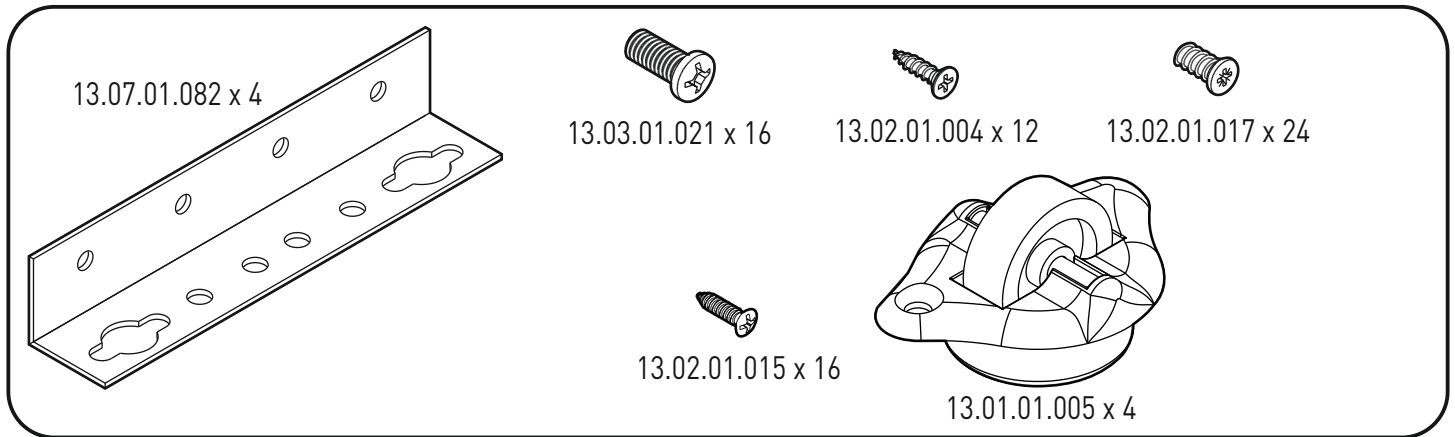
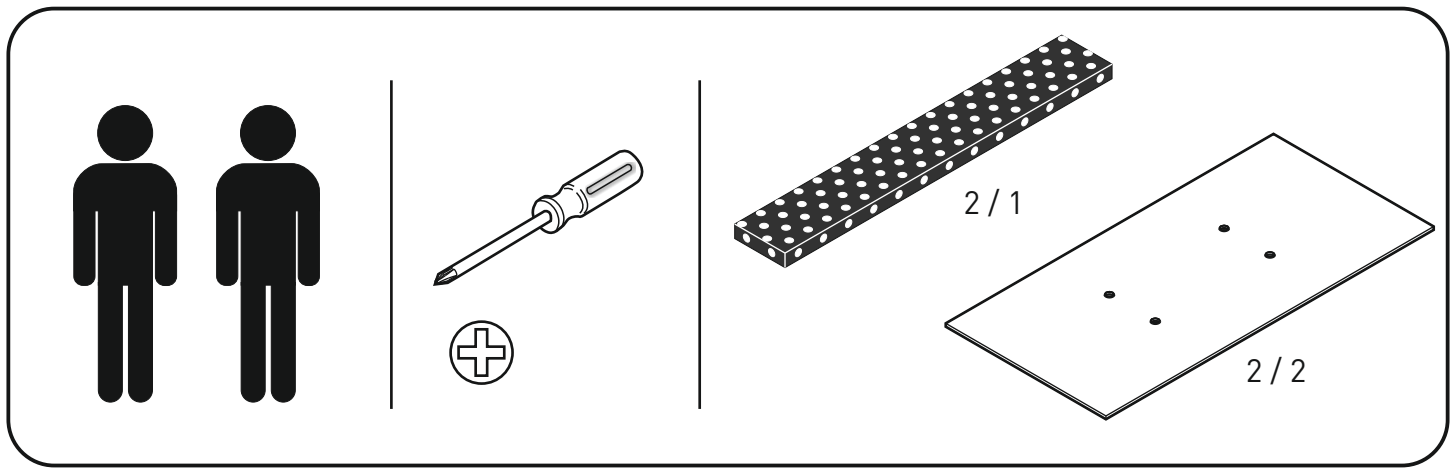
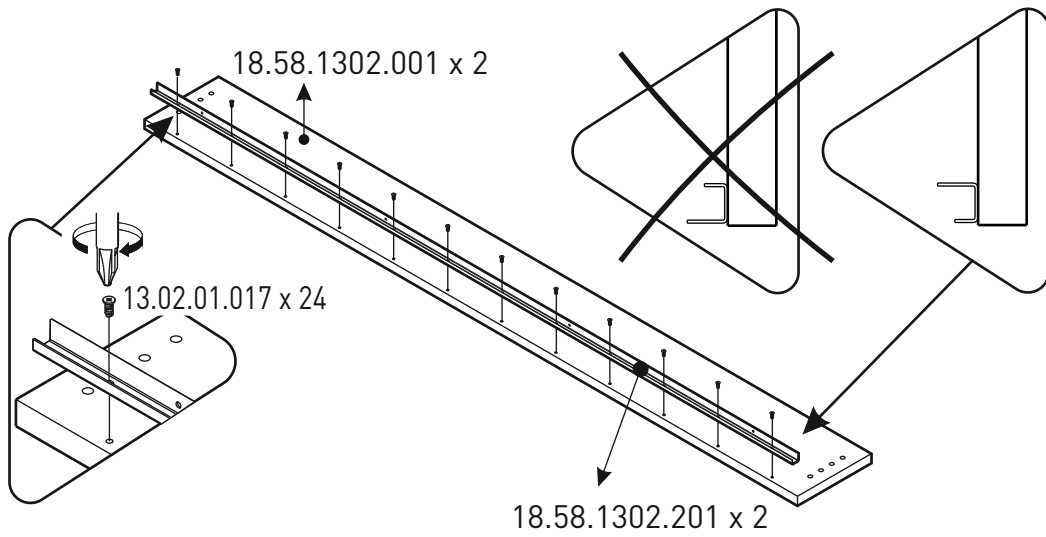

3

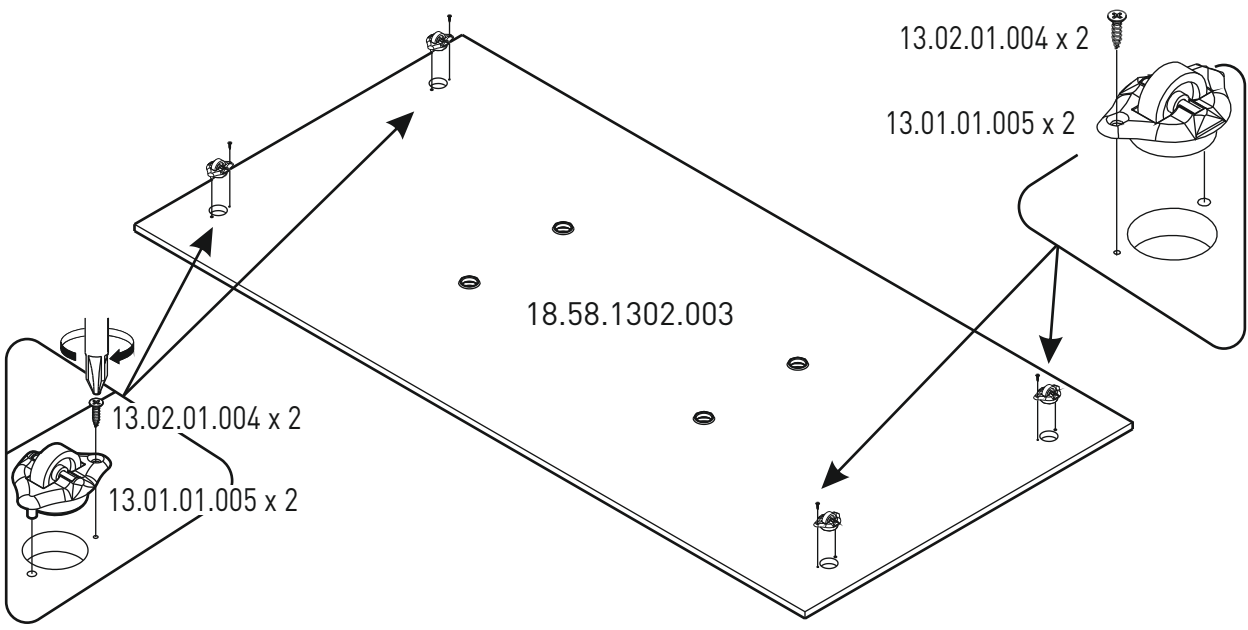

4

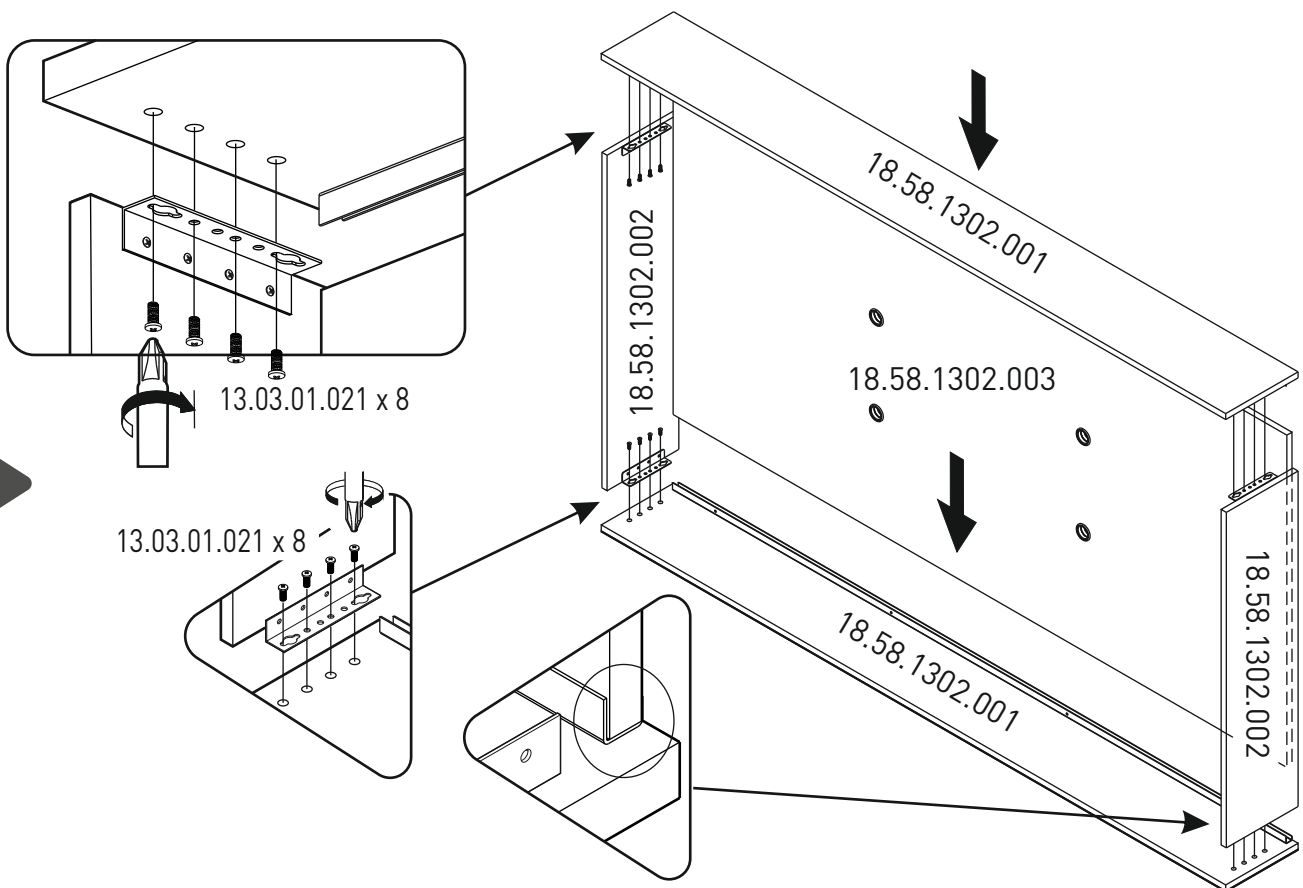

5

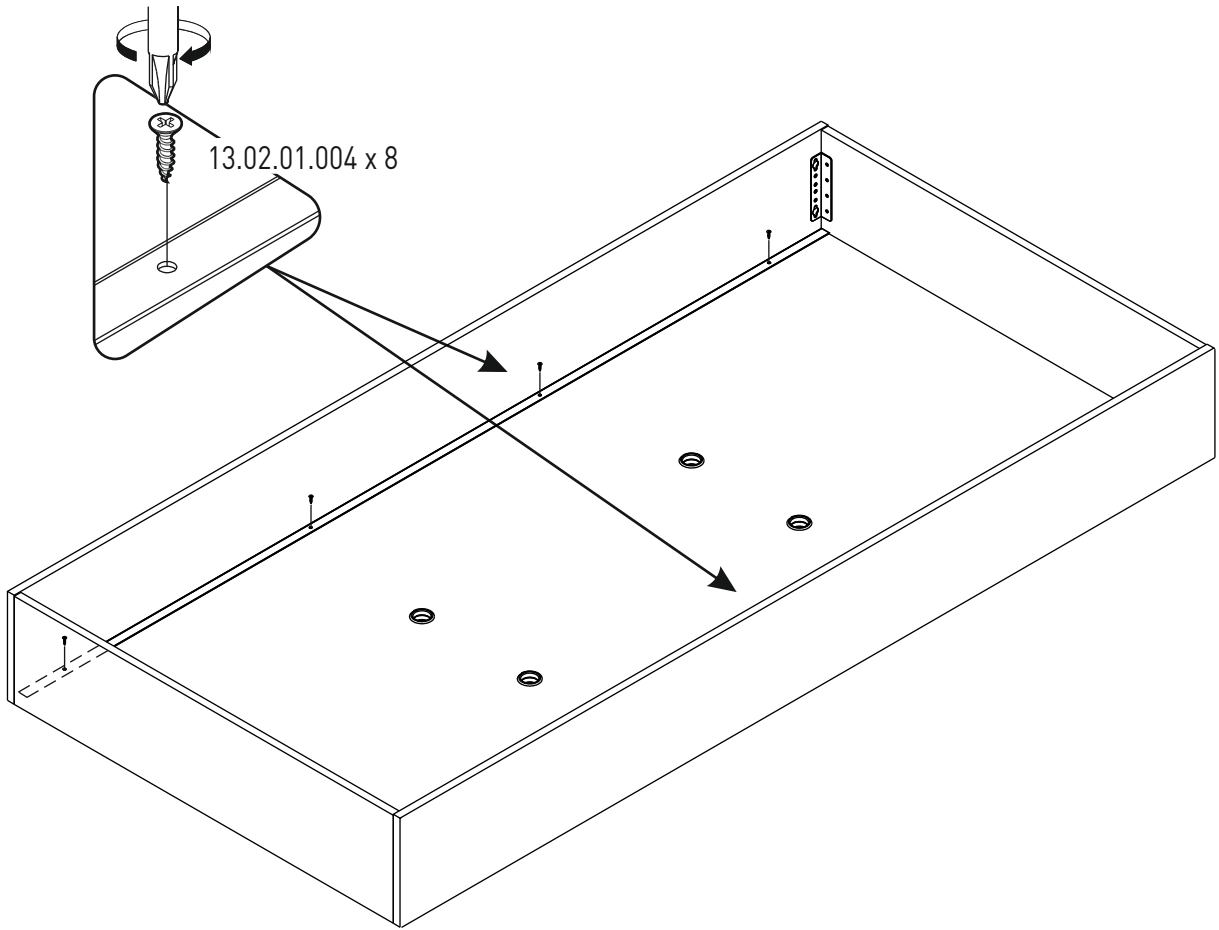

6

